

# DIY2416 Gaby jersey dress

## #gabyjerseydress

Seam allowance is included on all patterns:

Hem line 3 cm

Sleeve hem 3 cm

All other seams 1 cm

### You need to cut the following parts

Part 1	Front	x 1
Part 2	Back	x 1
Part 3	Sleeve	x 2
Part 4	Neck edge	x 1

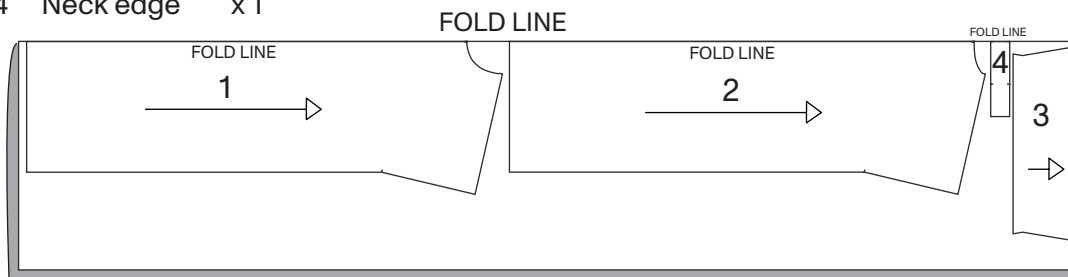
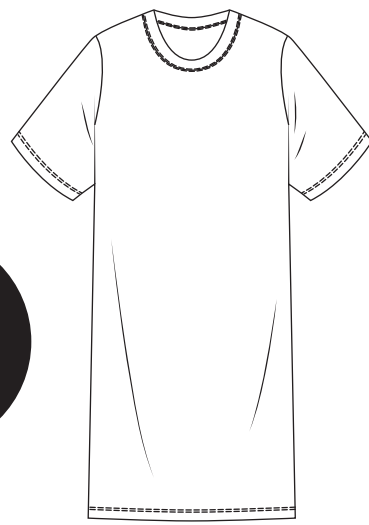

### You need the following fabric and accessories

Size	XS/S	M/L	XL/XXL	
Fabric:	w/145 cm	340	340	340 cm

### Pick your size

XS/S	-----
M/L	.....
XL/XXL	_____

Accessories:

Optional: 1 set of shoulder pad art nr. 37093 black or 37090 white

### Symbols you may find on your patterns

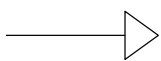

Grain line

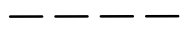

Fold line

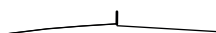

Notch



Gathering

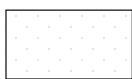

Interlining



Cut line

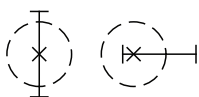

Placement of button and buttonhole

10 CM

## Self made®

**CONTROL SQUARE:**  
Print this page, to check the square measurements:  
If the measurements do not match, please adjust your printer settings.

**CONTROL PAGE FIT:**  
In print preview check page margin.  
Margin have to be equal on all 4 sides of each page.



▲  
*Unsure how to print?  
See this guide*

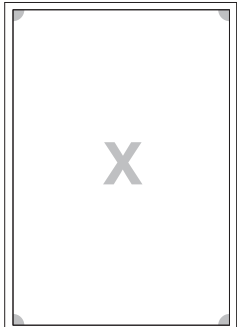

10 CM

Glue or tape your patterns together as shown in the diagram

**DIY2416 Gaby jersey dress #gabyjerseydress**

Seam allowance is included on all patterns  
 unless noted  
 All other units in cm

**You need to cut the following parts:**

Part 1	Front	x1
Part 2	Back	x1
Part 3	Sleeve	x2
Part 4	Neck edge	x1

**You need the following fabric and accessories:**

Size	XS	S	M	L	XL	XXL
Fabric	140 cm	140 cm	140 cm	140 cm	140 cm	140 cm

Accessories:  
 Optional 1 set of shoulder pad set or 2000 black or 2000 white

**10 CM Self made**  
 All rights reserved  
 CONTROL SQUARE: Check the square to check the fabric is square. If the measurements do not match, please adjust your fabric settings.  
 CONTROL PAGE FIT: Square the page margin along the top and bottom of all 4 sides of each page.

Glue or tape your patterns together as shown in the diagram

DIY2416 PART 1 FRONT x1 INCL SEAM ALLOWANCE

DIY2416 PART 2 BACK x1 INCL SEAM ALLOWANCE

DIY2416 PART 3 SLEEVE x2 INCL SEAM ALLOWANCE

DIY2416 PART 4 NECK EDGE x1 INCL SEAM ALLOWANCE

DIY2416 PART 5 FRONT x1 INCL SEAM ALLOWANCE

DIY2416 PART 6 BACK x1 INCL SEAM ALLOWANCE

DIY2416 PART 7 WAISTBAND x1 INCL SEAM ALLOWANCE

DIY2416 PART 8 SLEEVE CAP x1 INCL SEAM ALLOWANCE

DIY2416 PART 9 SLEEVE CUFF x1 INCL SEAM ALLOWANCE

DIY2416 PART 10 NECK EDGE x1 INCL SEAM ALLOWANCE

DIY2416 PART 11 WAISTBAND x1 INCL SEAM ALLOWANCE

DIY2416 PART 12 WAISTBAND x1 INCL SEAM ALLOWANCE

DIY2416 PART 13 WAISTBAND x1 INCL SEAM ALLOWANCE

DIY2416 PART 14 WAISTBAND x1 INCL SEAM ALLOWANCE

DIY2416 PART 15 WAISTBAND x1 INCL SEAM ALLOWANCE

DIY2416 PART 16 WAISTBAND x1 INCL SEAM ALLOWANCE

DIY2416 PART 17 WAISTBAND x1 INCL SEAM ALLOWANCE

DIY2416 PART 18 WAISTBAND x1 INCL SEAM ALLOWANCE

DIY2416 PART 19 WAISTBAND x1 INCL SEAM ALLOWANCE

DIY2416 PART 20 WAISTBAND x1 INCL SEAM ALLOWANCE

Free download from Selfmade.com

3

▶ extend 100 cm

FOLDLINE

4  
Self  
made®

DIY2416

PART 1

FRONT

✂ x1

INCL. SEAM ALLOWANCE

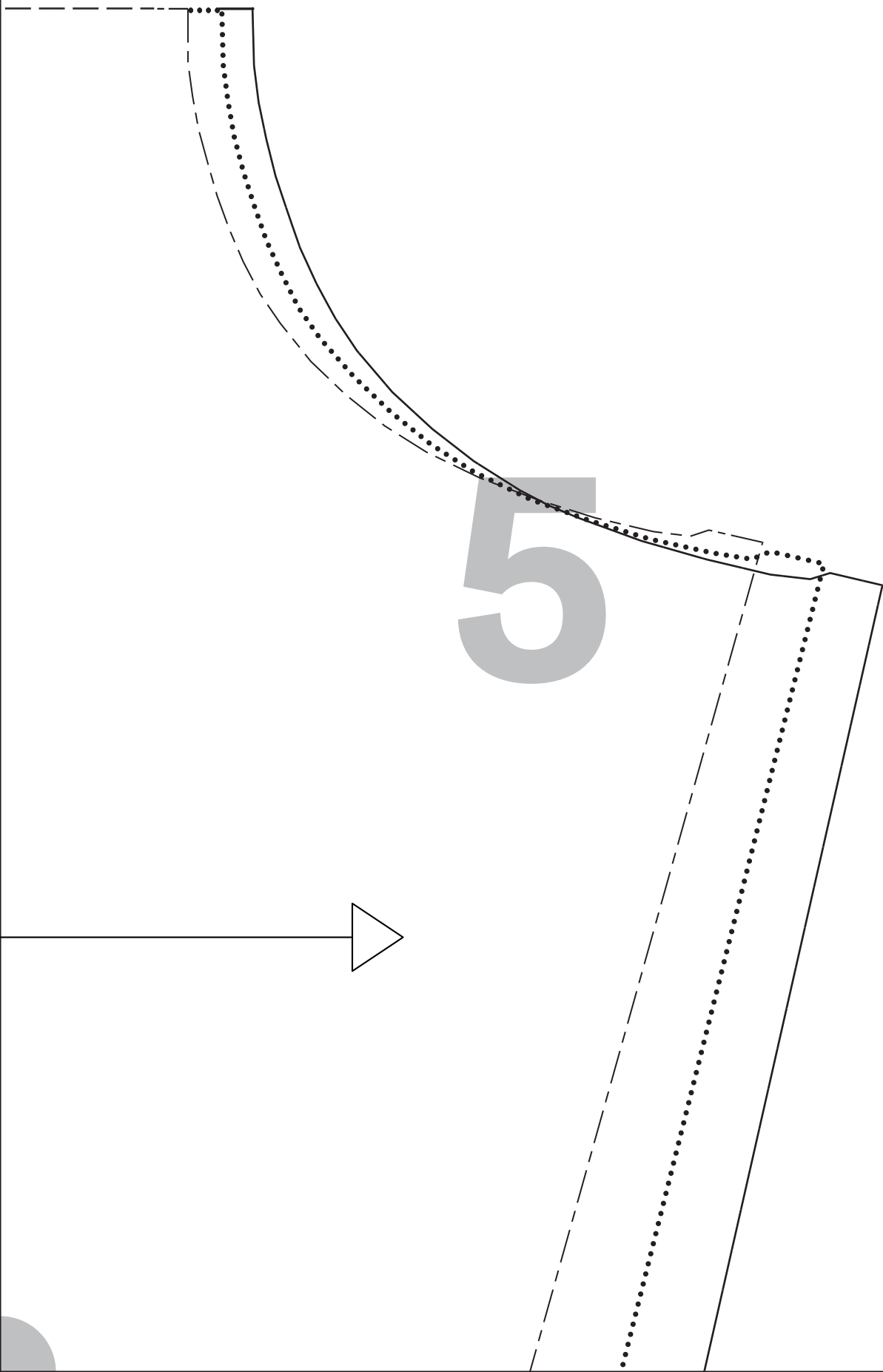

5

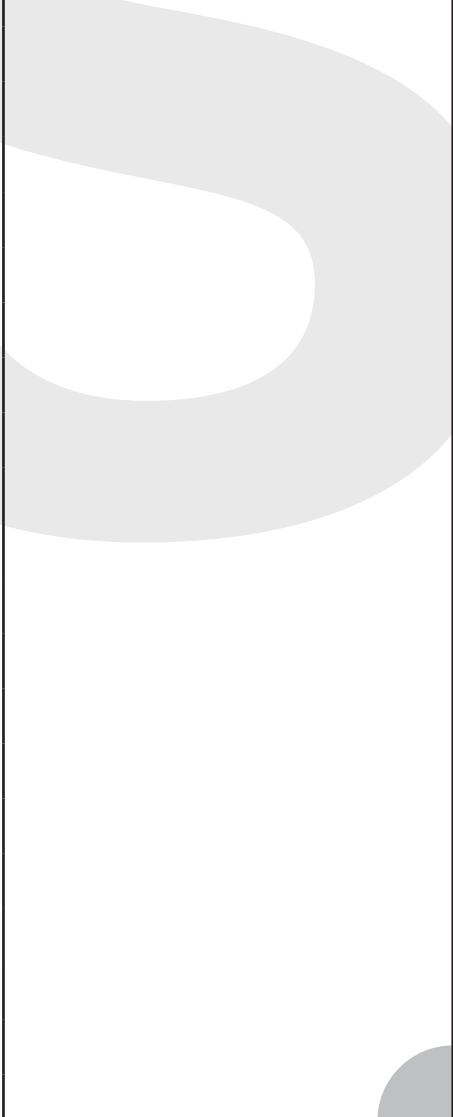
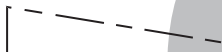
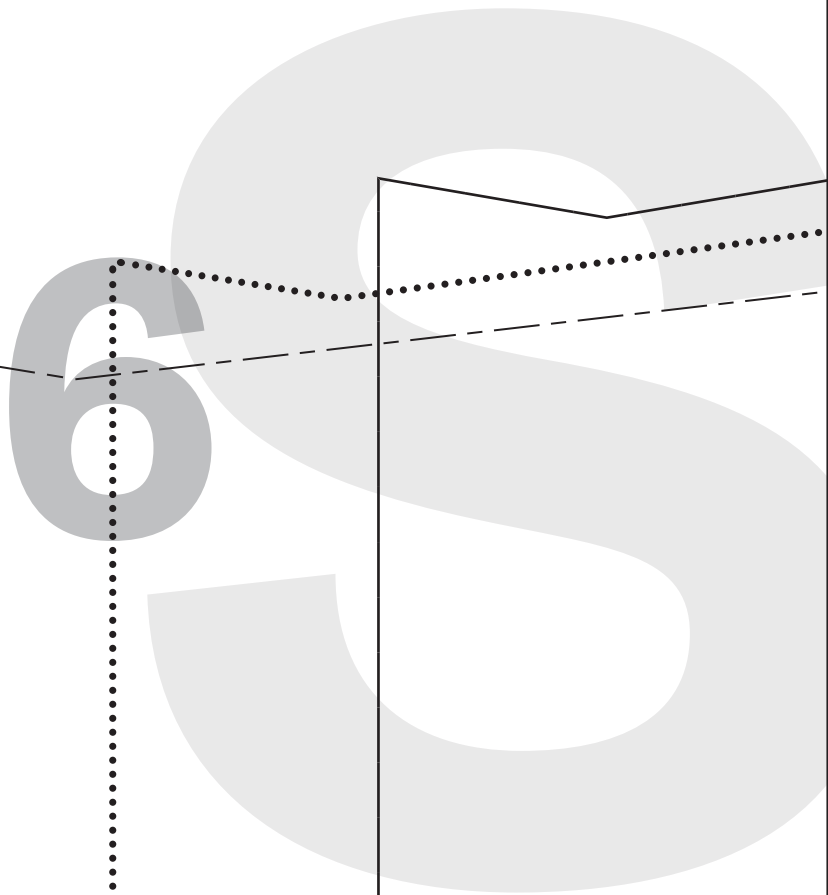

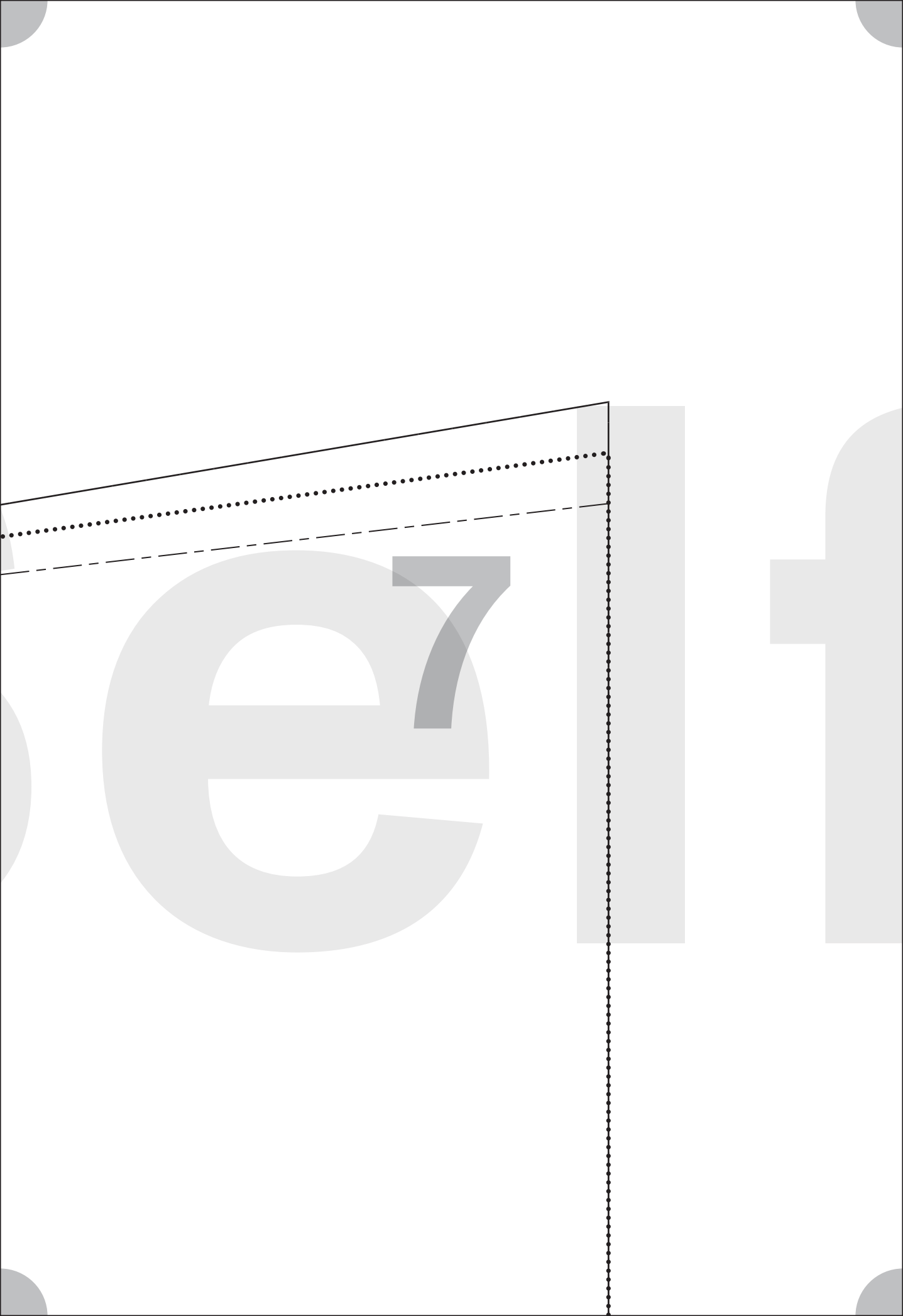

Free download from

extend 100 cm

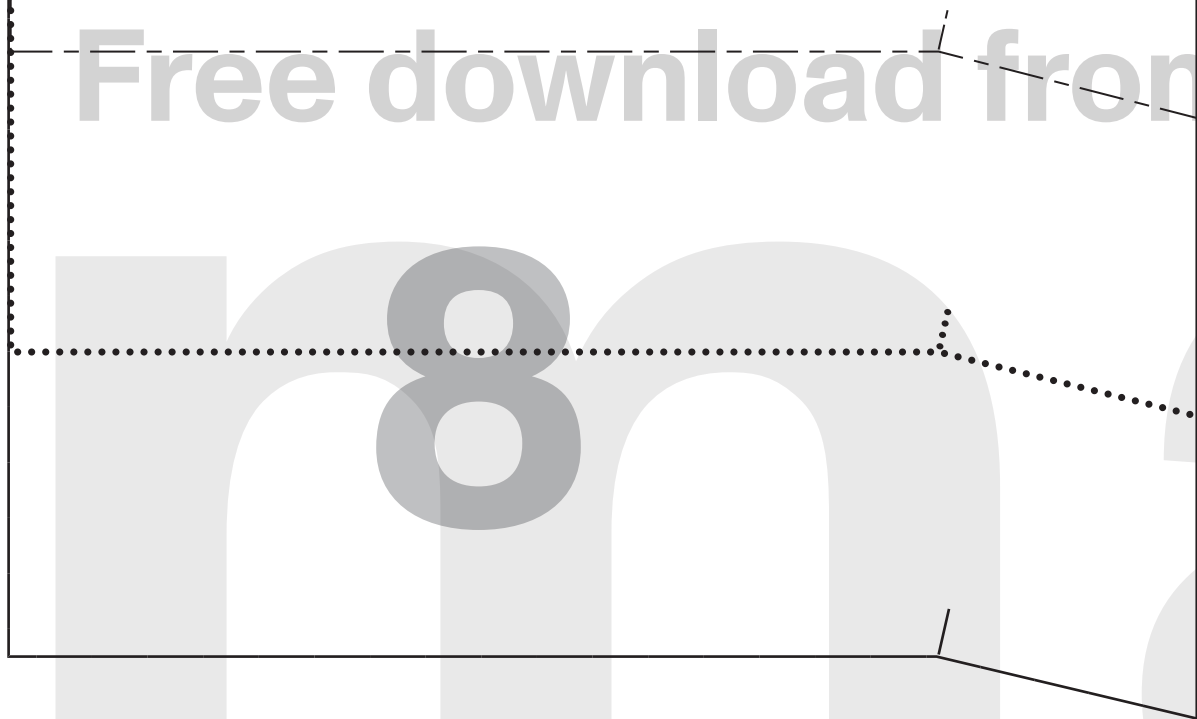

n Selfmade.com

901

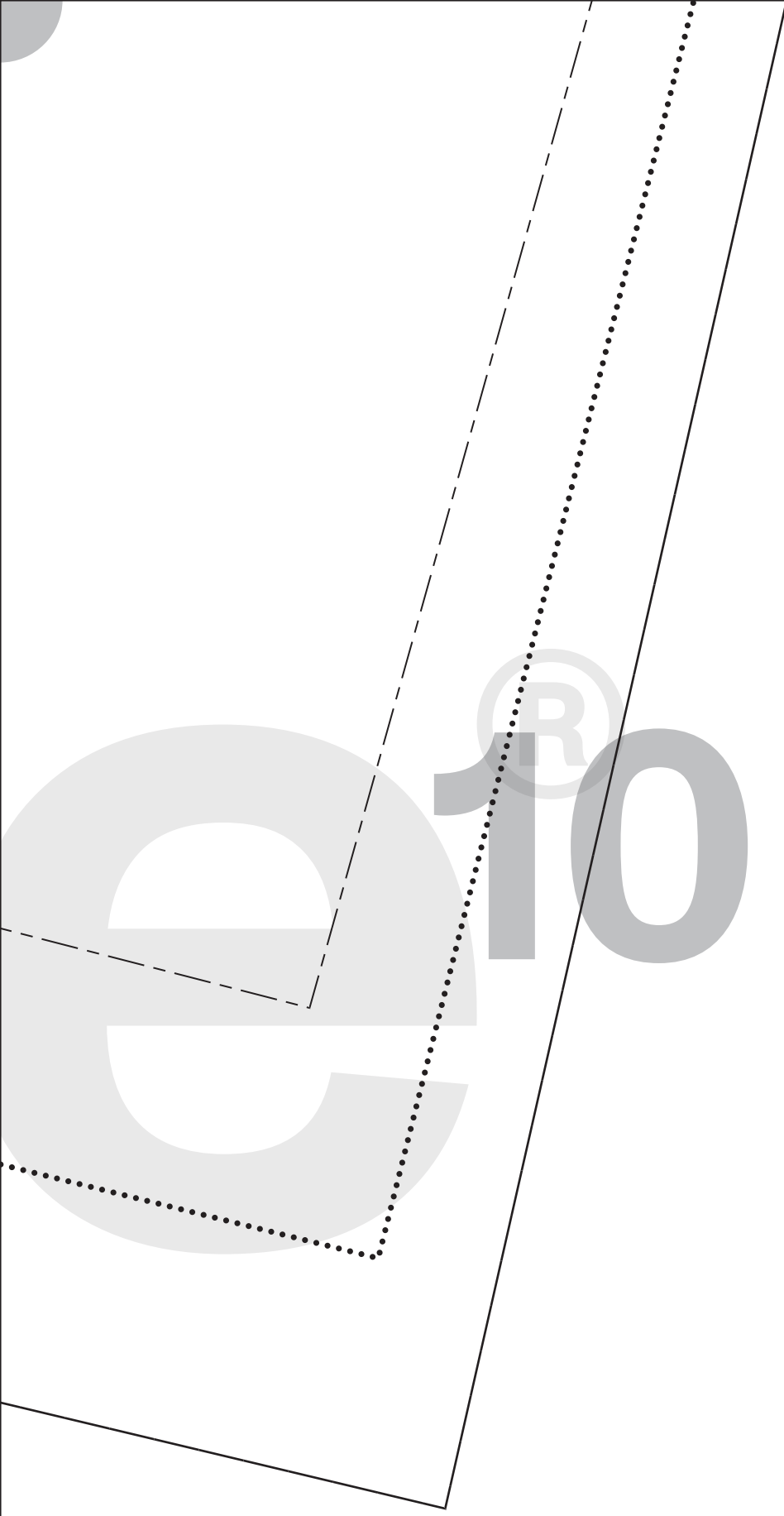

11

S



DIY2416

PART 3

SLEEVE

✂ x 2

INCL. SEAM ALLOWANCE



Free download from

f13n

FOLDLINE

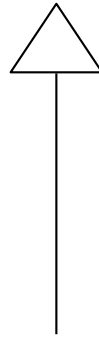

n Selfmade.com

14

arold

DIY2416  
PART 4  
NECK EDGE

✂ x 1

INCL. SEAM ALLOWANCE

©  
15

extend 100 cm

16

S

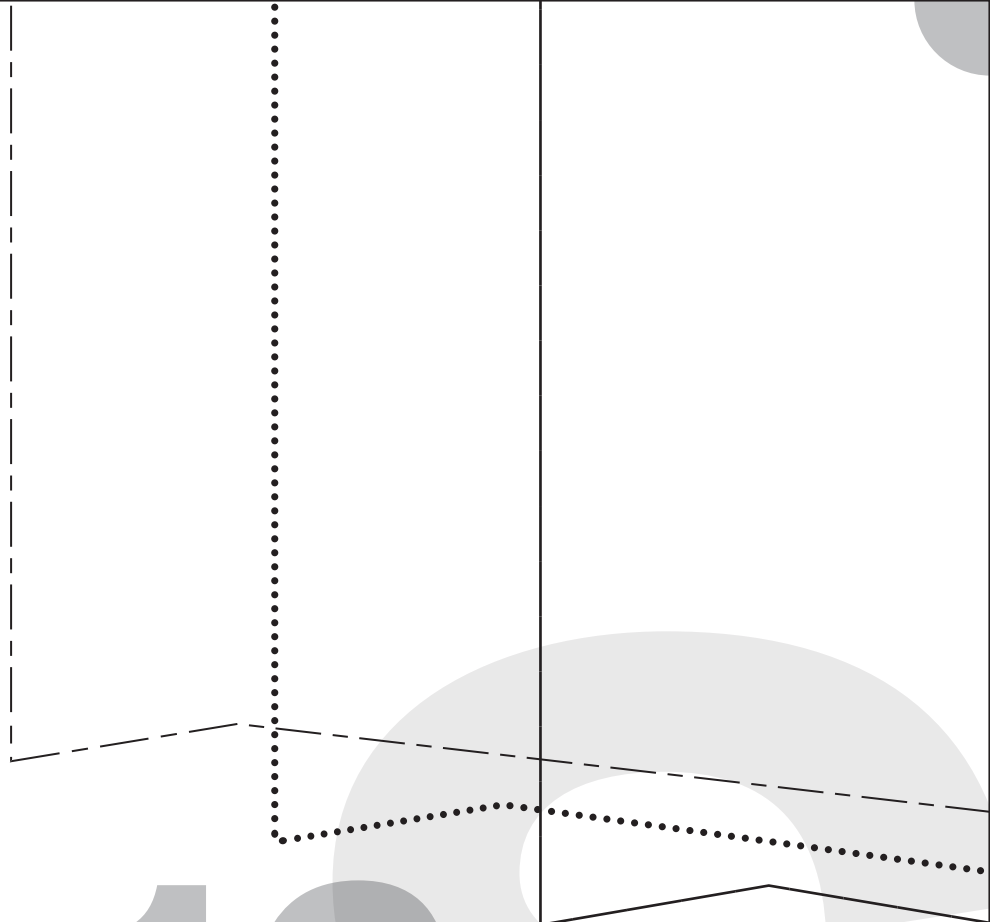

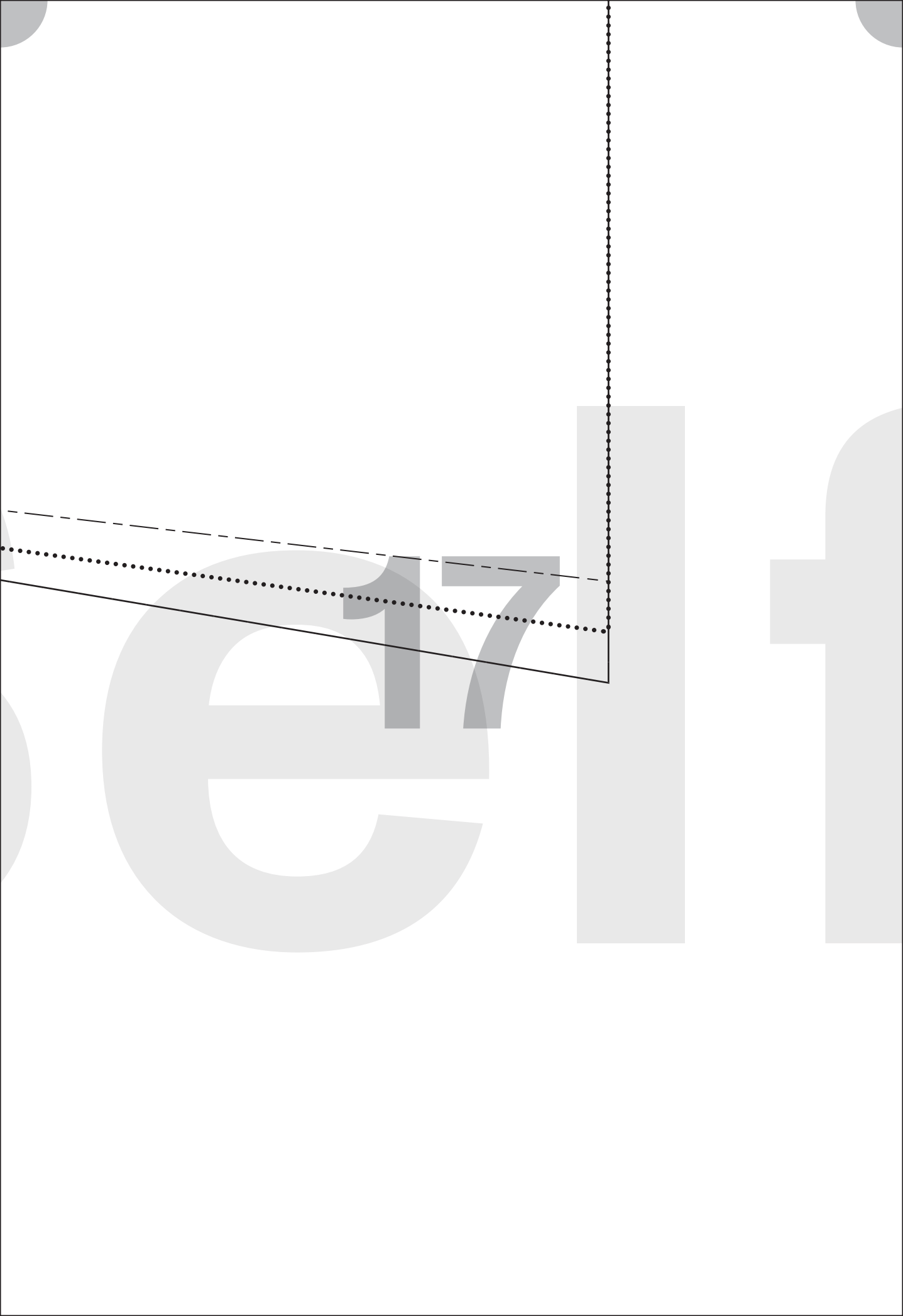

Free download from



18

INCL. SEAM ALLOWANCE

✂ x1

BACK

PART 2

DIY2416

on Selfmade.com

fold 19

FOLDLINE

e20®

▼ extend 100 cm